

Slotted Standard Brackets

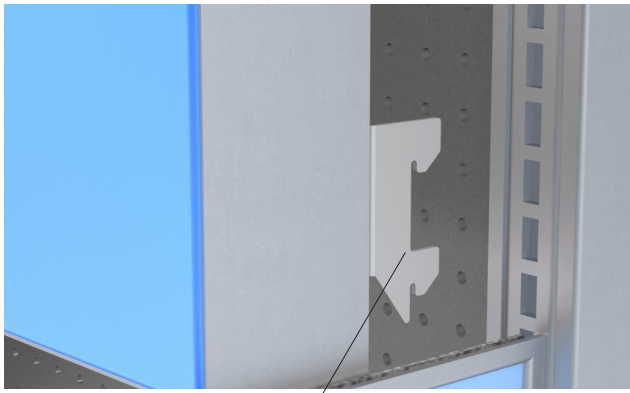

Laser cut bracket to engage upright

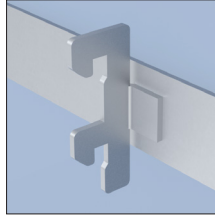

Laser Cut Brackets

To fit into your Slotted standards, Recessed standards, Lozier, Madix, or Opto. Can be engineered to fit into any standard pattern (slotted, tear drop, etc)

Hinged Shelf Covers

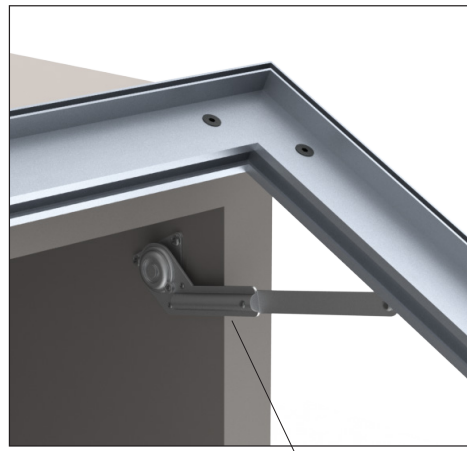

Soft close, stay open hinge
Covers shelves with or without merchandise



U Brackets

Fits over existing fixture



Graphic Frame "Wings"

Pegboard / Slatwall Standoffs



Shelf Attachment

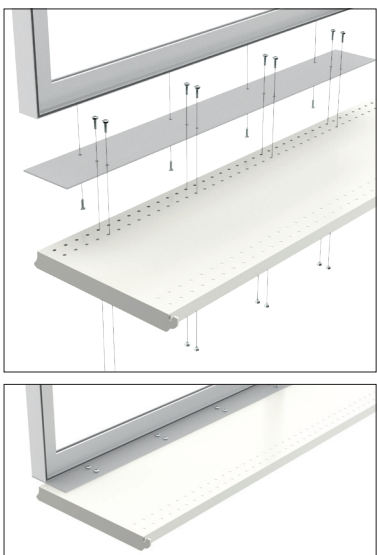

Drop into Uprights

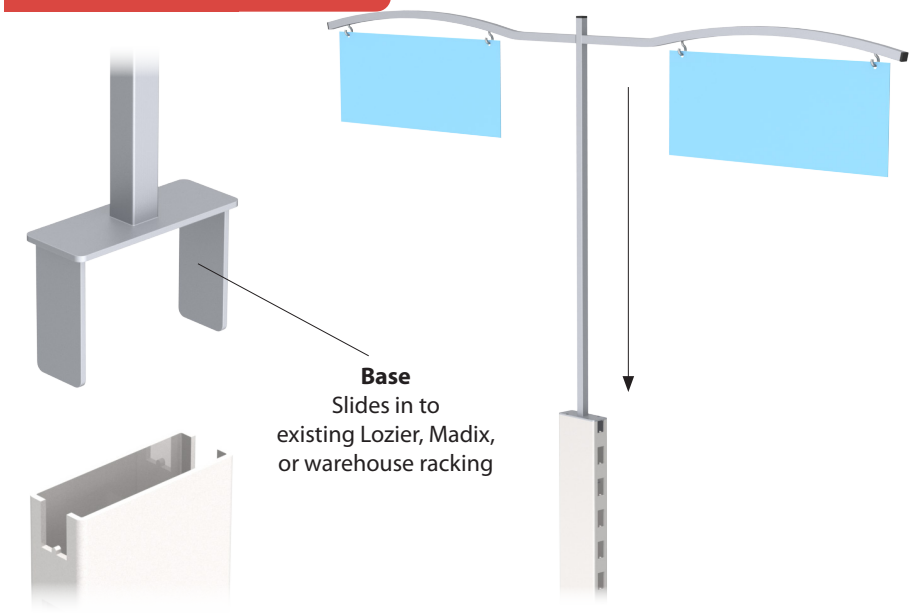

Base
Slides in to existing Lozier, Madix, or warehouse racking

Clamp Under Case

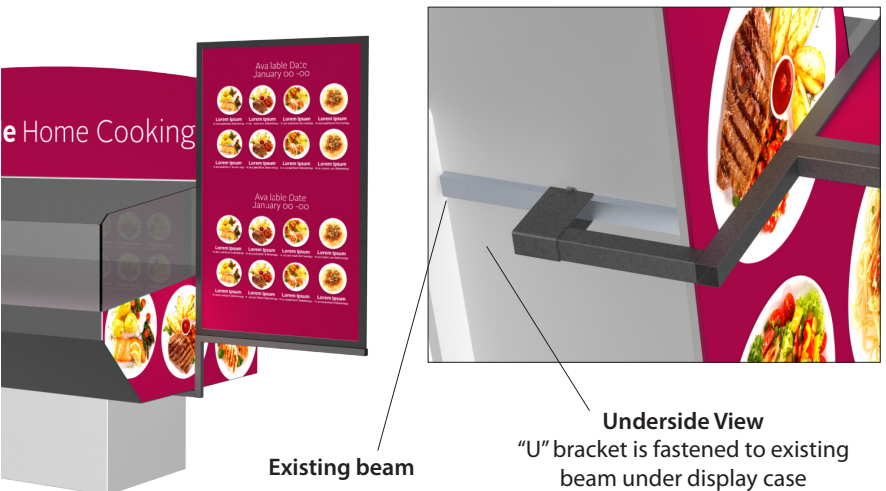

Existing beam

Underside View
"U" bracket is fastened to existing beam under display case

Clamp Bases



Swivel parallel or perpendicular

Drop into Existing Cup Bracket

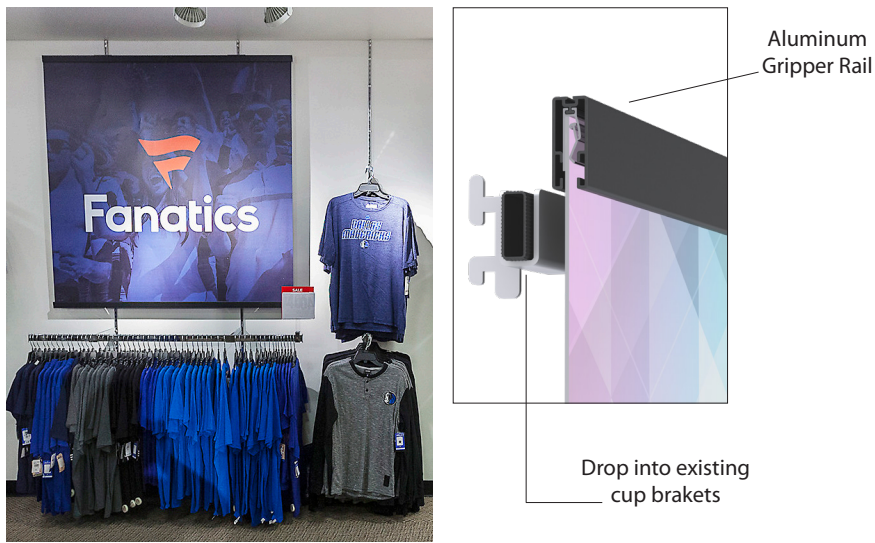

Standoff from 1/2" Merchandising Bar

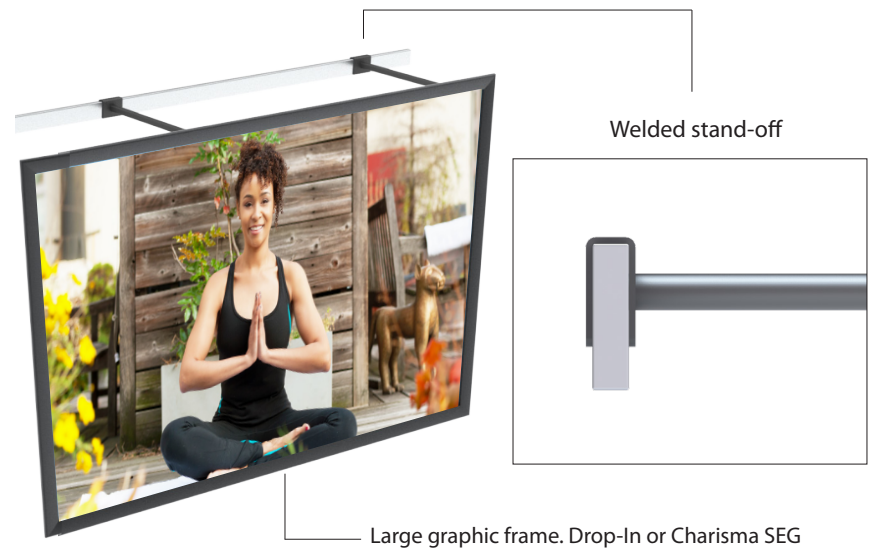

Shelf Divider Graphics



Angled Header Standoff Frame

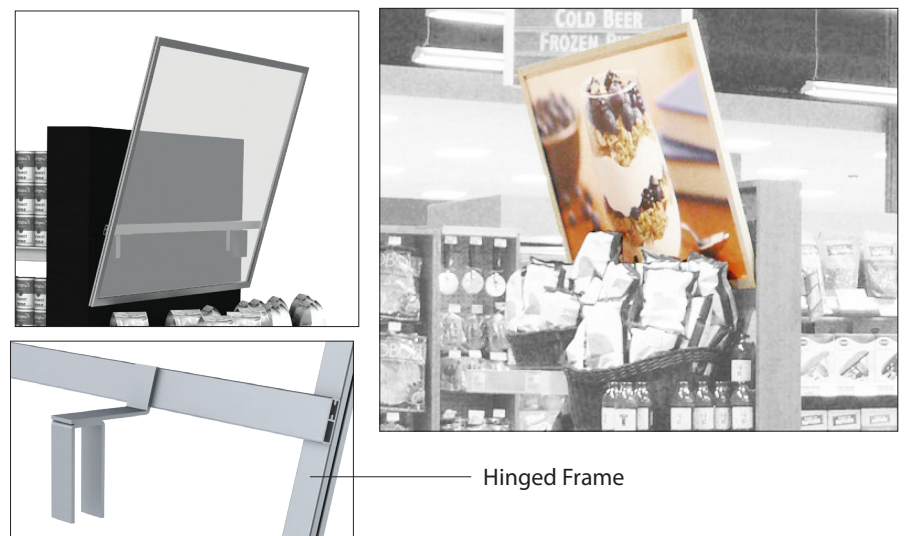

Merchandising Arm Signs



Fixture Cover

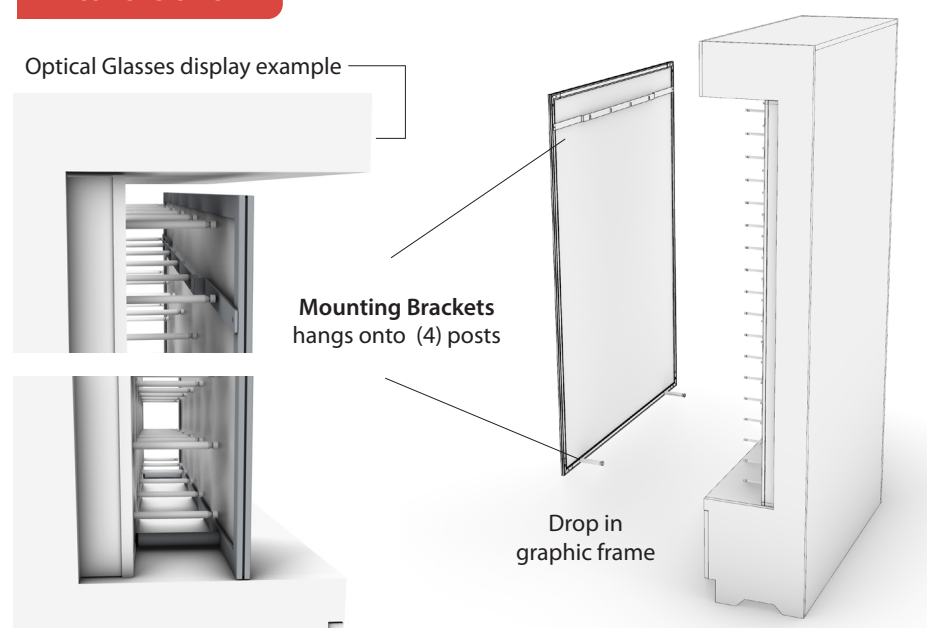

Fixture Spine Shoe Divider

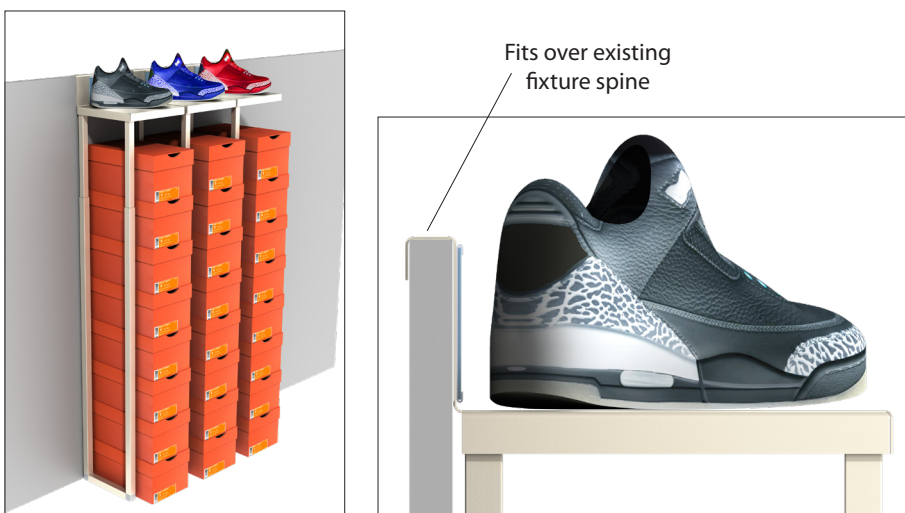

Pole Frame Mount

